

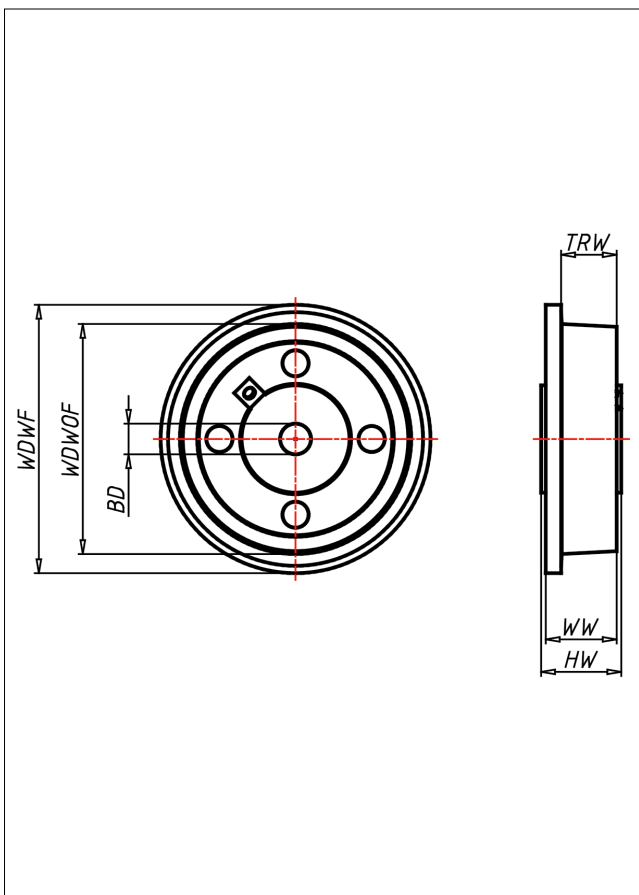

# SP Spurkranzrad

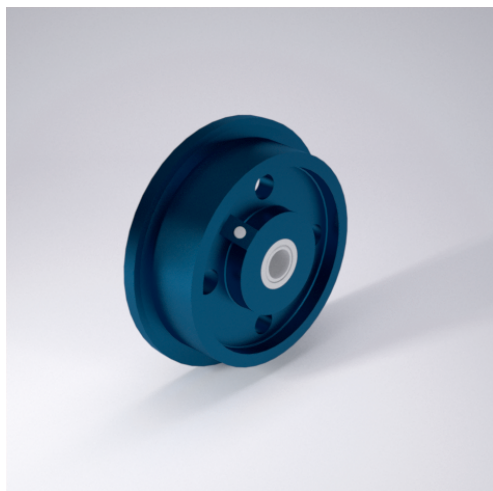

## SP Spurkranzrad



Spurkranzrad aus Eisenguss  
Lauffläche sauber überdreht, Neigungswinkel 3°  
Ausführung lackiert

- sehr hohe Tragkraft
- sehr abriebfest
- für hohe Temperaturen

## Technische Details

ORDERNO (Artikel-nummer)	250 SPK 30
WDWOF (Rad-Ø o. Spurkranz / mm)	250
WDWF (Rad-Ø m. Spurkranz / mm)	300
TRW (Laufflächenbreite / mm)	50
WW (Radbreite / mm)	65
LC (Tragkraft / kg)	2000
HW (Nabellänge / mm)	70
WB (Radlager)	Kugellager
BD (Bohrungsdurchmesser / mm)	30